

ESCO

WORLD CLASS. WORLDWIDE.



CelCulture® CO₂ Incubators

CelCulture®

CO₂ Incubators
Cradle for Beautiful Cells

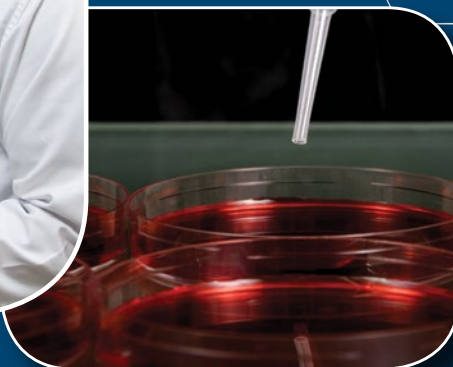

Designed in the USA

Table of Contents

About Esco	03
Esco Products Overview	05
Esco CO ₂ Incubators	
• CelCulture®	06
• CelCulture® with UV Lamp	14
• CelCulture® with Copper Interior Chamber	15
• CelCulture® with Integrated Cooling System	16
• CelCulture® with Stainless Steel Exterior	17
• CelCulture® for <i>In Vitro</i> Fertilization	18
Options and Accessories	21
CelCradle™ Bioreactor	25





Welcome to Esco

Esco's Vision is to provide enabling technologies for scientific discoveries to make human lives healthier and safer.



Esco represents innovation and forward-thinking designs, which are all coupled with the highest standard quality since 1978. The Esco Group of Companies remains dedicated in delivering innovative solutions for the clinical, life sciences, research, industrial, laboratory, pharmaceutical and IVF community. With the most extensive product line in the industry, our products have passed a number of international standards and certifications. Esco operates under ISO 9001, ISO 14001 and ISO 13485.

Availability and Accessibility. Headquartered in Singapore, manufacturing facilities are located in Asia and Europe. R&D is conducted worldwide spanning the US, Europe and Asia. Sales, services and marketing subsidiaries are located in 12 major markets including the US, UK, Japan, China and India. Our regional distribution centers are located in Bangladesh, China, Denmark, Germany, Hong Kong, India, Indonesia, Italy, Japan, Lithuania, Malaysia, Philippines, Russia, Singapore, South Africa, South Korea, Russia, Taiwan, Thailand, UAE, United Kingdom, USA, and Vietnam. Because of our worldwide presence, you can be sure that Esco is within your reach.

High Quality, Reliable and Dependable. Our customers are confident that only with the best quality, reliable, and dependable products, can they be sure of the accuracy of their research and procedures. Cross functional teams from Esco Production, R&D, Quality Assurance and Senior Management, are regularly assembled to review and implement areas for improvement.

Esco Cares for Your Safety. Esco focuses on providing safety not just for your samples but also for you and the environment.

Esco Cares for Your Comfort. Comfort of our users is ensured by building ergonomic designs and by reducing the noise levels of the units.

Esco Cares for the Environment. One in every four of Esco's employees is involved in Research and Development and a number of these evaluate new components and/or designs to produce energy efficient equipment. Being GREEN is more than just modifying the parts we use to produce a new energy efficient technology, it also embodies the every aspect of the company.

Customer Service and Support. Our service does not stop once purchase has been made. Esco gives on-time customer service and offers end-user seminars, service training, preventive maintenance, provides educational materials and informative videos.

As Esco takes the opportunity to respond to the world's needs, we aim not just to contribute in the advancement of scientific discoveries but also in making the world a safer, healthier and a better place to live in.

Research and Development

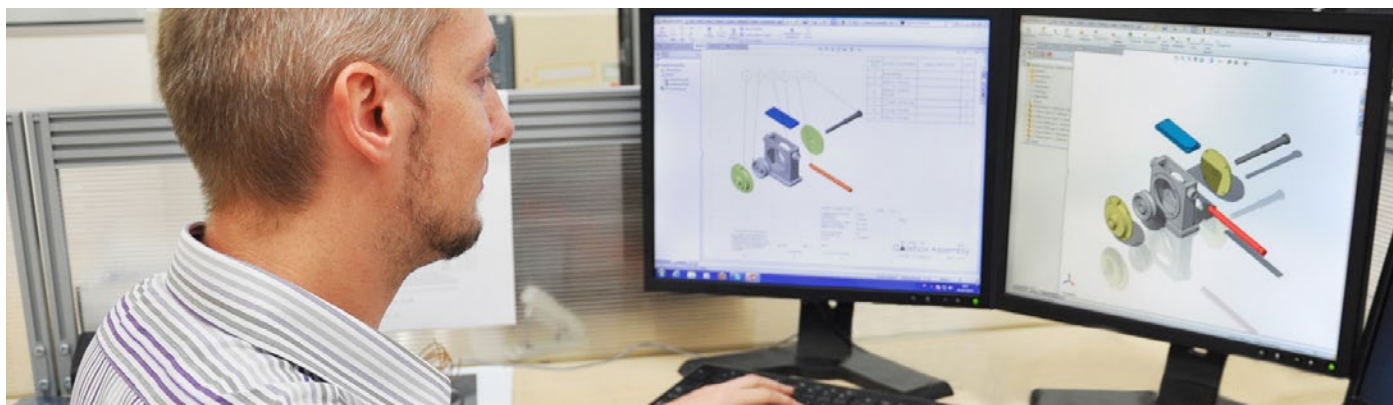

An integral part of our business planning effort is based on managing a robust research and development program in Singapore, China, Europe and the USA, balanced against an investment in service support, training and customer education. Compared to industry averages, Esco invests a significant percentage of annual revenues in research and development. As a result of our investment, and with continuous feedback and idea evaluation among our research, global sales, marketing, purchasing and manufacturing teams; Esco products reflect the best contemporary designs in performance, ergonomics and customer satisfaction.

- Engineers located in technology centers in Singapore, China, Europe and the USA
- Growing patent portfolio
- Core competencies:
 - Embedded system, sensor and software development and integration
 - Containment engineering for biohazards, chemical vapors and hazardous powders
 - Decontamination cycle development
 - Computational fluid dynamics
 - Temperature, humidity, gas and environmental control
 - Imaging systems
 - Wireless and remote monitoring
 - cGMP laboratory design

Production and Quality



Esco's manufacturing advantage stems from our extensive degree of vertical integration, enabled by our world-leading high throughput. All processes, with a few exceptions, are performed in-house. This allows us to achieve quality and reliability that is truly world class.

- Incoming materials inspection and warehousing
- CNC-controlled sheet metal fabrication
- Full range of welding including MIG, TIG, Spot, and Robotic welding
- Environment-friendly powder coating lines
- Electromechanical final product assembly
- Electrical / electronics sub-assembly
- Multi-step electrical and physical performance testing
- Independent quality control at each step in the production cycle
- Microbiology, chemistry, containment test labs
- Instruments calibration laboratory

Esco's focus on quality and timeliness is relentless. Continuous improvement is a mantra. Cross-functional teams from Esco Production, R&D, Quality Assurance, Senior Management, are regularly assembled to review and implement areas for improvement.

Every year, Esco manufacturing site is audited by certification bodies like ISO 9001, ISO 14001, ISO 13485, NSF International, and TUV Nord Germany. Our machines safety, workplace safety, and environmental safety are also audited by different government institutions.

All of the third party audits help our customer to ensure Esco manufacturing sites consistency of producing quality products and continual improvement.

Products and Application

Life Sciences Laboratory Equipment

Sample Preparation

- Class I Biological Safety Cabinets
- Class II Type A2 Biological Safety Cabinets
- Class II Type B1 Biological Safety Cabinets
- Class II Type B2 Biological Safety Cabinets
- Class III Biological Safety Cabinets
- Horizontal Laminar Flow Clean Benches
- Vertical Laminar Flow Clean Benches
- Laboratory Animal Research Workstations
- Laboratory Centrifuges

Sample Cultivation

- CO₂ Incubators, Direct Heat Air-Jacketed
- CO₂ Incubators with Cooling System
- CO₂ Incubators with Stainless Steel Exterior
- Laboratory Shakers

Sample Analysis

PCR Thermal Cyclers

- Conventional Thermal Cyclers
- Real-time PCR Systems

PCR Sample Handling

- Microplate Shakers
- PCR Cabinets

Sample Storage & Sample Protection Solutions

- Ultra-low Temperature Freezers
- Lab Refrigerators and Freezers
- Sample Database Management Software
- Intelligent Remote Monitoring Application Protocol
- Remote Monitoring, Datalogging, Programming Software
- Wireless Monitoring System

Chemical Research

- Ductless Fume Hoods
- Laboratory Fume Hoods
- Fume Hood Airflow Monitors
- Exhaust Blowers
- Powder Weighing Balance Enclosures

General Equipment

Laboratory Thermostatic Products

- Laboratory Oven
- Forced Convection Laboratory Incubator
- Natural Convection Laboratory Incubator
- Refrigerated Incubator

Forensic Sciences

- Evidence Drying Cabinet

Medical / IVF Equipment

Controlled Embryo Handling

- Fertilisafe™ ART Workstation
- AVT-I Anti Vibration Table
- Semi Closed Environment IVF

Safe Embryo Culture

- Miri® Multi room Benchtop Incubator
- CelCulture® CO₂ Incubator
- Mini Miri® Humidified Benchtop Incubator

Innovative Time Lapse Imaging

- Miri® Time-lapse Incubator

Accurate Quality Control

- Miri® GA Gas and Temperature Validation Unit
- Miri® GA Mini Gas Validation Unit

Unique Consumables

- CultureCoin

Healthcare

Esco Pharma Products

Airflow Containment Products

- Pharmacon® Downflow Booths
- Ceiling Laminar Airflow Units
- Laminar Flow Horizontal/Vertical Trolley
- Enterprise™ Laminar Flow Straddle Unites
- Cytoculture™ Cytotoxic Safety Cabinets

Isolation Containment

- Aseptic Containment Isolator (ACTI)
- Weighing and Dispensing Containment Isolator (WDCI)
- General Processing Platform Isolator (GPPI)
- Containment Barrier Isolator (CBI)
- Turbulent Flow Aseptic (Grade A) Isolator (TFAI)
- Isoclean® Healthcare Platform Isolator (HPI)
- Streamline® Compounding Isolators (SCI)
- Technetium Dispensing Isolators
- Blood Cell Labeling Isolators
- Open and Closed Restricted Barrier Access Systems (RABS)

Cross Contamination Facility Integrated Barrier

- BioPass™ Pass Through
- Infinity® Air Shower Pass Box
- Cleanroom Air Shower
- Infinity® Cleanroom Transfer Hatch
- Infinity® Pass Box
- Soft capsule® Soft Wall Cleanroom
- Dynamic Passboxes and Dynamic Floor Label Hatches
- Laminar Flow Storage Cabinet

Ventilation Containment

- Ventilated Balance Enclosure

VacciXcell Products

Bioreactors and Fermenters

- CelCradle™
- TideCell®
- VacciXcell™ Hybrid Bioreactor

Cell Culture Monitoring, Media and Consumables

- Super Plus™
- Plus™ Vero
- Plus™ MDCK
- Plus™ MDCK II
- BioNOC™ II macrocarriers
- GlucCell® Glucose Monitoring System
- CVD Kit

Filling Line Equipment

- Filling Line Isolators
- cRabs (close restricted access barriers)
- oRabs (open restricted access barriers)

Integrated Solutions

- Cell Processing Isolator
- Cell Processing Center

TaPestle Rx Products and Services

PRODUCTS

- Pharmacy Automation and Compounding Supply
- Compounding Pharmacy Isolators (SCI, HPI, CBI, GPPI)
- Safety Cabinets and Enclosures (Class II BSC, VBE, LFC)
- Radiopharmacy Hoods and Isolators
- Aseptic Filling Systems

Healthcare and Laboratory Construction Components

- Prefabricated Walls (Airecell®)
- Prefabricated Containerized Facility (Prefab™)
- Series Ceiling Systems
- Hygienic/Hermetic Door Systems
- Surgical Scrub Sinks
- Vinyl Tiles and Epoxy
- Laboratory Fit-outs
 - Worktops
 - Frames
 - Specialty Storage cabinets
 - Service Spines & Reagent Shelving

SERVICES

- Conceptualization
- Planning
- Procurement
- Installation

FACILITY DESIGNS

- Process Architecture
- Biocontainment/Biosafety
- Pharmacy Compounding/Nuclear Medicine
- Cleanroom, Vaccine and Cell Processing
- Laboratory
- Containerized Facility
- ART/IVF
- Cold Chain



CelCulture® CO₂ Incubators

INTRODUCTION

CO₂ incubators are widely used in scientific research to grow and maintain cell cultures. Typical fields of application include tissue engineering, *in vitro* fertilization, neuroscience, cancer research and other mammalian cell research applications.

Sleek, reliable and intuitive, Esco CelCulture® CO₂ incubators provide complete sample protection that brings your scientific dreams one step closer to reality.

KEY FEATURES

CelCulture® CO₂ INCUBATORS *Cradle for Beautiful Cells*



CelCulture® CO₂ Incubators available in 3 sizes, 50 L, 170 L, and 240 L.

ULPA FILTER*

- 99.999% efficient, superior to conventional HEPA filters
- Filters air continuously
- Chamber returns to ISO Class 5 cleanliness in 11 minutes upon door closing to prevent contamination



SHELVING

- Perforated shelving to improve uniformity
- Anti-tip
- Stainless steel
- Built-in grip
- Dismantles without tools for easy cleaning

DIRECT HEAT & AIR JACKET

- Fast and uniform heating
- Rapid temperature recovery
- Air jacket improves chamber stability



DUCT WORK

- Directs air flow for rapid recovery and excellent uniformity
- Easily removed for cleaning



WATER PAN

- Precisely heated by base heater to provide high humidity
- Gentle airflow over water surface accelerates humidity recovery



ROUNDED CORNERS

- Seamless design
- Facilitates easier cleaning

O₂ SENSOR

for suppressed O₂ model

- Long life
- Stable output signal
- Not affected by CO₂ concentration inside the chamber

DOOR SWITCH

Automatically turns off the blower and gas supply when the door is opened

TOP COVER

Provides quick access to electrical panel components

CO₂ SENSOR

- IR Sensor
- Single-beam, dual-wavelength IR sensor is drift-free
- Auto-zeroing

SMARTSENSE™ MICROCONTROLLER INTERFACE

Intuitive, fully-equipped control and monitoring system

BLOWER*

Gentle airflow in chamber improves recovery and uniformity

OUTER DOOR

- Reversible
- Heated to prevent condensation

SAMPLE PORT

Allows direct measurement of chamber atmosphere such as temperature and CO₂ concentration

INNER GLASS DOOR

For observing sample cells inside the chamber during operation

DOOR LATCH

To lock / unlock the glass door

LEVELING FEET

Easily adjustable

QUALITY ESCO CONSTRUCTION

- Electrogalvanized steel with white oven-baked epoxy-polyester antimicrobial powder-coated finish.
- External surfaces are powder coated with Esco **ISOCIDE™** to eliminate 99.9% of surface bacteria within 24 hours of exposure.
- Ensures a healthier, safer and cleaner lab environment.

**Not available in 50 L Model (including the top and bottom plenum)*

VIVOCELL™ PRECISE PARAMETER CONTROL

BEST UNIFORMITY AND CONTROL AMONG THE COMPETITION

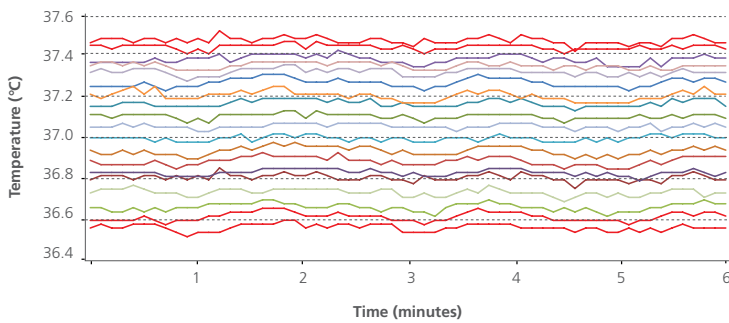

Different lines represent different sensor positions inside the chamber. Esco CelCulture® has uniformity variance of less than $\pm 0.5^\circ\text{C}$ which means all the samples are evenly heated.*

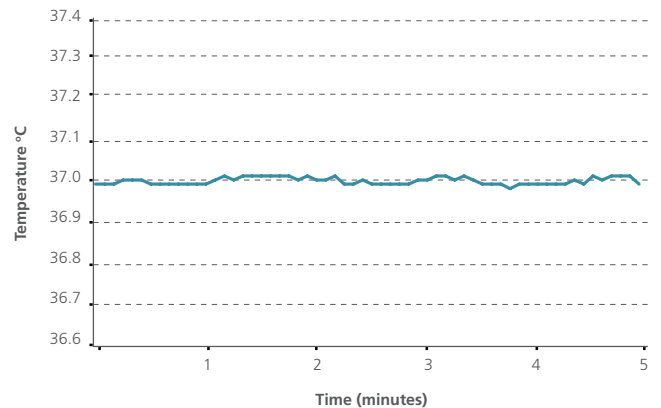

Minimal fluctuation ($\pm 0.2^\circ\text{C}$) ensures temperature stability.*

FAST CO₂, TEMPERATURE AND HUMIDITY RECOVERY WITHOUT OVERSHOOT

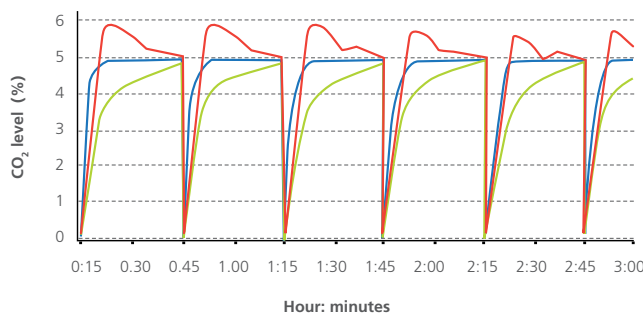

Precisely-tuned sensor and software result in fast recovery of CO₂ without overshoot. This ensures uniform CO₂ levels even with frequent incubator door opening.

Recovery of both temperature and humidity is twice as fast as conventional incubators.

- Company A's model: overshoot.
- Company B's model: slow recovery.
- Esco CelCulture®: fast recovery, no overshoot.

DIRECT HEAT AND AIR JACKET

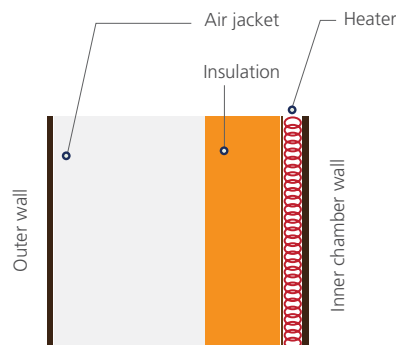
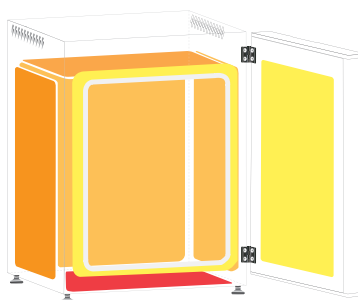

- Direct heating enables rapid temperature recovery while air jacket provides isolation against ambient temperature fluctuations.
- Precise heating in the chamber is achieved by using 8 heaters located in 3 zones. The 3 zones are intelligently controlled by the microcontroller for best temperature uniformity and minimal fluctuation.

- The main heater provides precise temperature control.
- The bottom heater warms the water pan and provides humidity.
- The outer door heater prevents condensation on glass door and facilitates temperature recovery.

VENTIFLOW™ FORCED CONVECTION

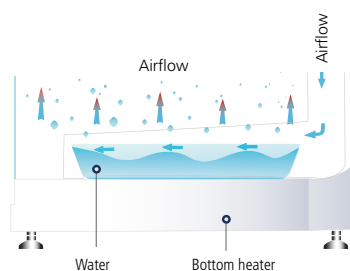
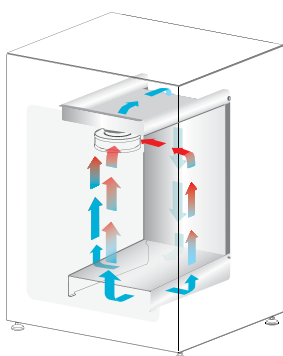

- No disturbance to cell culture.
- Blower automatically stops when door is opened to minimize mixing of chamber and room air.
- Accelerates recovery of chamber air to ISO Class 5 Cleanliness after door closing to prevent contamination.
- Improves CO₂, humidity and temperature uniformity.
- Filtered air circulates across water pan to accelerate humidifying process.

* Units were factory-tested under controlled environmental conditions per Esco method. Esco does not guarantee identical results in the field under differing conditions. Original report available upon request. Model used in the test is CCL-170B-8.

ROBUST CONTAMINATION CONTROL

STERISAFE™ ULPA FILTRATION SYSTEM

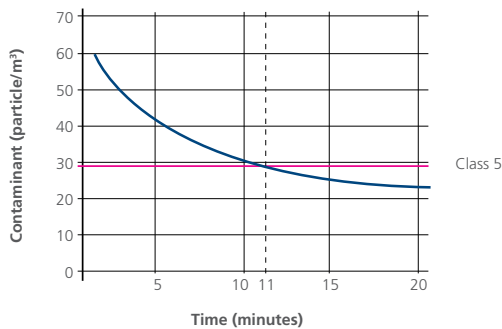

- Chamber air is continuously filtered by ULPA filters to keep the chamber at ISO Class 5 cleanliness. This ensures that all contaminants from both room air and chamber air are filtered, thus only clean air is recirculated.
- ULPA filters operate at 99.999% efficiency, superior to conventional HEPA filters which are 99.99% efficient.
- Chamber achieves ISO Class 5 cleanliness 11 minutes after door closing.*

* Units were factory-tested under controlled environmental conditions per Esco method. Esco does not guarantee identical results in the field under differing conditions. Original report available upon request. Model used in the test was CCL-170B-8.

VALIDATED SWIFTCON™ OVERNIGHT DECONTAMINATION CYCLE

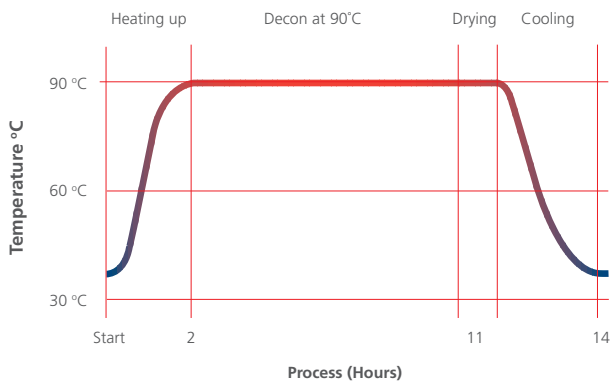

Microorganisms	Before Decon	After Decon
<i>Bacillus atrophaeus</i>	1.59 x 10 ⁶	0
<i>Aspergillus brasiliensis</i>	1.52 x 10 ⁴	0
<i>Pseudomonas aeruginosa</i>	2.38 x 10 ⁶	0
<i>Staphylococcus epidermis</i>	2.33 x 10 ⁶	0
<i>Escherichia coli</i>	1.57 x 10 ⁶	0
<i>Staphylococcus aureus</i>	5.72 x 10 ⁶	0
<i>Enterobacter faecalis</i>	2.15 x 10 ⁶	0

- The automated SwiftCon™ 90°C moist heat decontamination cycle has been proven effective in deactivating normally resistant fungi, bacterial spores and vegetative cells by the Health Protection Agency (HPA) in UK.
- Full decontamination cycle completes within 15 hours.
- Chamber is cool and dry at the end of the cycle. No further wipe down is needed.*

- Independently proven to be as effective as high temperature decontamination.
- Lower temperature causes less damage to electronic components, therefore prolongs the life span of the incubator.

*Not applicable to CCL-50L unit since it has no decon pump to dry the chamber and condensation will normally occur in the chamber after the cycle. Further wipe down is therefore required after the cycle is done.

GAS INJECTION LINES ARE FILTERED



- All gas injection lines are filtered via 0.2 micron inlet filters to remove impurities and contaminants before being injected into the chamber.
- Inlet filters are field-replaceable and are located external to the incubator.

CONTROLLER TYPE

USER - FRIENDLY SOFTWARE INTERFACE

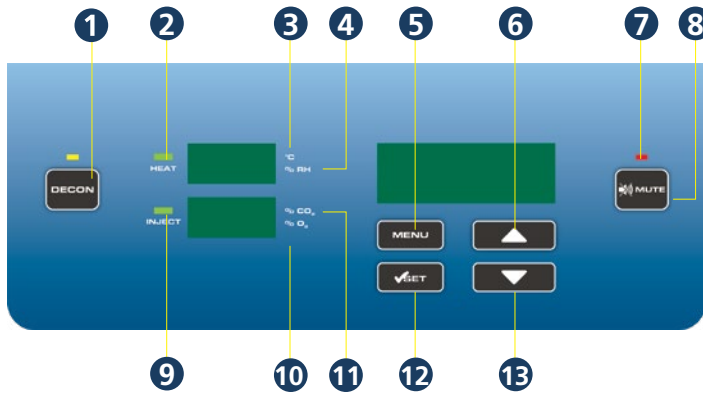

- 1. **Start / stop decontamination cycle**
- 2. **HEAT LED**
Lights up when heat is applied to chamber
- 3. **°C is lit when displaying the temperature**
- 4. **% RH is lit when displaying the humidity level**
- 5. **Enter menu / go back to previous menu**
- 6. **Scroll up / increase value**
- 7. **ALARMS LED**
Will blink when errors and warnings occur
- 8. **Mute alarms**
- 9. **INJECT LED**
Lights up when gas is injected
- 10. **% O₂ is lit when displaying the O₂ concentration**
- 11. **% CO₂ is lit when displaying the CO₂ concentration**
- 12. **Confirm value / enter a menu**
- 13. **Scroll down / decrease value**

Comprehensive, user-configurable alarms:

- Temperature
- CO₂
- Humidity (if installed)
- O₂ (if installed)

CelAlert™ alarm system reminds user to replace parts.

```
NEW CO2 TANK
CO2 TANK NET WEIGHT
IN KG: 0031
NEW CO2 TANK IS SET
```

In addition to CO₂ tank low alarm, CelAlert™ has CO₂ tank depletion reminder that automatically calculates how much CO₂ gas is left in the tank and alerts user to replace the tank one week before the gas is depleted. This gives the user some buffer time to place orders for new tanks.

```
SET ULPA REMINDER
ULPA REMINDER
TIME <MONTHS> :12
REMINDER IS SET
```

ULPA reminder will alert user to replace ULPA filter.

Intelligent data and event logger records all incubator parameters for on-screen recall. A 2 MB built-in flash memory guarantees long-term storage of data.

```
MAIN MENU
CALIBRATION
ADMIN
>DATALOGGING
```

```
DATALOGGING
>SHOW TEMP DATA LOG 012016 0724 36.8°C
SHOW %CO2 DATA LOG 012016 0719 37.0°C
DATA LOG PERIOD 012016 0714 37.1°C
012016 0709 37.3°C
```

Diagnostic interface and online quick help provide comprehensive solutions to frequently encountered problems.

Voyager®

Remote Monitoring, Datalogging, Programming Software

Esco Voyager® is a PC-based software package developed for the remote monitoring, datalogging, and programming / device configuration of Esco thermostatic products.

A centralized monitoring and control system for the laboratory, Esco Voyager® provides extra protection for you and your samples.

Voyager® interfaces with individual Esco equipment over RS485 using the EscoBUS communications protocol. Multiple equipment may be interfaced to a single PC.

Compatible Equipment

- Lexicon® - Ultra-low Temperature Freezer
- CelCulture® - CO₂ Incubator (CCL)
- CelMate® - CO₂ Incubator (CLM)
- Isotherm® - Forced Convection Oven (OFA)
- Isotherm® - Forced Convection Incubator (IFA)
- Isotherm® - Refrigerated Incubator (IFC)
- Isotherm® - Natural Convection Incubator (INA)



TESTING & CERTIFICATION



For IVF applications, Esco CelCulture® CO₂ incubators are certified embryo-safe.

Rigorously tested with the Mouse Embryo Assay (MEA), the CelCulture® remarkably has 100% embryo survival. The Mouse Embryo Assay (MEA) is the de facto standard test done to demonstrate that a procedure or an article of equipment is safe to use for manipulating human embryos (e.g., *in vitro* fertilization or IVF).



The Esco CelCulture® CO₂ incubator is listed by Underwriters Laboratory (UL), to meet the requirements of both the U.S. and Canada standards for electrical/mechanical integrity.

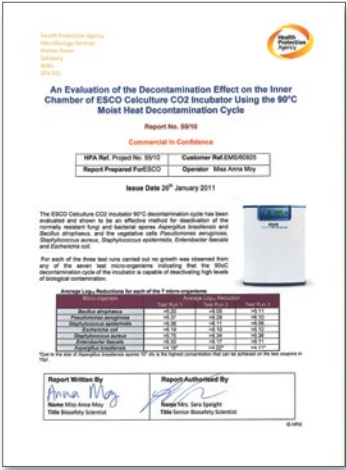

HPA Validated Decontamination Cycle

The Esco CelCulture® CO₂ Incubator's 90°C decontamination cycle has been evaluated and shown to be an effective method for deactivation of the normally resistant fungi and bacterial spores of *Aspergillus brasiliensis* and *Bacillus atrophaeus*, and the vegetative cells of *Pseudomonas aeruginosa*, *Staphylococcus aureus*, *Staphylococcus epidermidis*, *Enterobacter faecalis* and *Escherichia coli*.

ORDERING INFORMATION

IR SENSOR MODEL WITH STAINLESS STEEL CHAMBER		
MODELS	ITEM CODE	DESCRIPTION
CCL-050B-8	2170034	CelCulture® Incubator 50 L, IR Sensor, CO ₂ Control, Moist Heat Decon, 230 VAC, 50/60 Hz, (Without Decon Pump)
CCL-170B-8	2170002	CelCulture® Incubator 170 L, IR Sensor, CO ₂ Control, ULPA, Moist Heat Decon, 230 VAC, 50/60 Hz,
CCL-170B-8-NF	2170068	CelCulture® Incubator 170 L IR Sensor, CO ₂ Control, Moist Heat Decon, 230 VAC, 50/60 Hz, (No ULPA Filter)
CCL-240B-8	2170058	CelCulture® Incubator 240 L, IR Sensor, CO ₂ Control, ULPA, Moist Heat Decon, 230 VAC, 50/60 Hz
CCL-240B-8-NF	2170069	CelCulture® Incubator 240 L, IR Sensor, CO ₂ Control, Moist Heat Decon, 230 VAC, 50/60 Hz, (No ULPA Filter)
CCL-050B-9	2170054	CelCulture® Incubator 50 L, IR Sensor, CO ₂ Control, Moist Heat Decon, 115 VAC, 50/60 Hz (Without Decon Pump)
CCL-170B-9	2170004	CelCulture® Incubator 170 L, IR Sensor, CO ₂ Control, ULPA, Moist Heat Decon, 115 VAC, 50/60 Hz
CCL-170B-9-NF	2170075	CelCulture® Incubator 170 L IR Sensor, CO ₂ Control, Moist Heat Decon, 115 VAC, 50/60 Hz, (No ULPA Filter)
CCL-240B-9	2170060	CelCulture® Incubator 240 L, IR Sensor, CO ₂ Control, ULPA, Moist Heat Decon, 115 VAC, 50/60 Hz
CCL-240B-9-NF	2170079	CelCulture® Incubator 240 L, IR Sensor, CO ₂ Control, Moist Heat Decon, 115 VAC, 50/60 Hz, (No ULPA Filter)

SUPPRESSED O ₂ MODEL WITH STAINLESS STEEL CHAMBER		
MODELS	ITEM CODE	DESCRIPTION
CCL-050T-8	2170055	CelCulture® Incubator 50 L, IR Sensor, CO ₂ & O ₂ Control, Moist Heat Decon, 230 VAC, 50/60 Hz (Without Decon Pump)
CCL-170T-8	2170047	CelCulture® Incubator 170 L, IR Sensor, CO ₂ & O ₂ Control, ULPA, Moist Heat Decon, 230 VAC, 50/60 Hz
CCL-170T-8-NF	2170070	CelCulture® Incubator 170 L, IR Sensor, CO ₂ & O ₂ Control, Moist Heat Decon, 230 VAC, 50/60 Hz (No ULPA Filter)
CCL-240T-8	2170061	CelCulture® Incubator 240 L, IR Sensor, CO ₂ & O ₂ Control, ULPA, Moist Heat Decon, 230 VAC, 50/60 Hz
CCL-240T-8-NF	2170071	CelCulture® Incubator 240 L, IR Sensor, CO ₂ & O ₂ Control, Moist Heat Decon, 230 VAC, 50/60 Hz (No ULPA Filter)
CCL-050T-9	2170056	CelCulture® Incubator 50 L, IR Sensor, CO ₂ & O ₂ Control, Moist Heat Decon, 115 VAC, 50/60 Hz (Without Decon Pump)
CCL-170T-9	2170048	CelCulture® Incubator 170 L, IR Sensor, CO ₂ & O ₂ Control, ULPA, Moist Heat Decon, 115 VAC, 50/60 Hz
CCL-170T-9-NF	2170076	CelCulture® Incubator 170L, IR Sensor, CO ₂ & O ₂ Control, Moist Heat Decon, 115VAC, 50/60HZ (No ULPA Filter)
CCL-240T-9	2170062	CelCulture® Incubator 240 L, IR Sensor, CO ₂ & O ₂ Control, ULPA, Moist Heat Decon, 115 VAC, 50/60 Hz
CCL-240T-9-NF	2170080	CelCulture® Incubator 240L, IR Sensor, CO ₂ & O ₂ Control, Moist Heat Decon, 115VAC, 50/60HZ (No ULPA Filter)

IR SENSOR MODEL WITH STAINLESS STEEL CHAMBER WITH FLAT DOOR DESIGN

MODELS	ITEM CODE	DESCRIPTION
CCL-050B-8-FD	2170150	CelCulture® Incubator 50 L, IR Sensor, CO ₂ Control, Moist Heat Decon, Flat Door, 230 VAC, 50/60 Hz (Without Decon Pump)
CCL-170B-8-FD	2170117	CelCulture® Incubator 170 L, IR Sensor, CO ₂ Control, ULPA, Moist Heat Decon, Flat Door, 230 VAC, 50/60 Hz
CCL-170B-8-NF-FD	2170243	CelCulture® Incubator 170 L, IR Sensor, CO ₂ Control, Moist Heat Decon, Flat Door, 230 VAC, 50/60 Hz, (No ULPA Filter)
CCL-240B-8-FD	2170123	CelCulture® Incubator 240 L, IR Sensor, CO ₂ Control, ULPA, Moist Heat Decon, Flat Door, 230 VAC, 50/60 Hz
CCL-240B-8-NF-FD	2170244	CelCulture® Incubator 240 L, IR Sensor, CO ₂ Control, Moist Heat Decon, Flat Door, 230 VAC, 50/60 Hz, (No ULPA Filter)
CCL-050B-9-FD	2170191	CelCulture® Incubator 50 L, IR Sensor, CO ₂ Control, Moist Heat Decon, Flat Door, 115 VAC, 50/60 Hz (Without Decon Pump)
CCL-170B-9-FD	2170120	CelCulture® Incubator 170 L, IR Sensor, CO ₂ Control, ULPA, Moist Heat Decon, Flat Door, 115 VAC, 50/60 Hz
CCL-240B-9-FD	2170126	CelCulture® Incubator 240 L, IR Sensor, CO ₂ Control, ULPA, Moist Heat Decon, Flat Door, 115 VAC, 50/60 Hz
CCL-170B-8-UV-FD	2170119	CelCulture® Incubator 170L, IR Sensor, CO ₂ Control, ULPA, UV Lamp, Moist Heat Decon, Flat Door, 230VAC, 50/60Hz
CCL-240B-8-UV-FD	2170124	CelCulture® Incubator 240L, IR Sensor, CO ₂ Control, ULPA, UV Lamp, Moist Heat Decon, Flat Door, 230VAC, 50/60Hz

SUPPRESSED O₂ MODEL WITH STAINLESS STEEL CHAMBER WITH FLAT DOOR DESIGN

MODELS	ITEM CODE	DESCRIPTION
CCL-050T-8-FD	2170149	CelCulture® Incubator 50 L, IR Sensor, CO ₂ & O ₂ Control, Moist Heat Decon, Flat Door, 230 VAC, 50/60 Hz (Without Decon Pump)
CCL-170T-8-FD	2170118	CelCulture® Incubator 170 L, IR Sensor, CO ₂ & O ₂ Control, ULPA, Moist Heat Decon, Flat Door, 230 VAC, 50/60 Hz
CCL-170T-8-NF-FD	2170247	CelCulture® Incubator 170 L, IR Sensor, CO ₂ & O ₂ Control, Moist Heat Decon, Flat Door, 230 VAC, 50/60 Hz (No ULPA Filter)
CCL-240T-8-FD	2170125	CelCulture® Incubator 240 L, IR Sensor, CO ₂ & O ₂ Control, ULPA, Moist Heat Decon, Flat Door, 230 VAC, 50/60 Hz
CCL-240T-8-NF-FD	2170249	CelCulture® Incubator 240 L, IR Sensor, CO ₂ & O ₂ Control, Moist Heat Decon, Flat Door, 230 VAC, 50/60 Hz (No ULPA Filter)
CCL-050T-9-FD	2170245	CelCulture® Incubator 50 L, IR Sensor, CO ₂ & O ₂ Control, Moist Heat Decon, Flat Door, 115 VAC, 50/60 Hz (Without Decon Pump)
CCL-170T-9-FD	2170148	CelCulture® Incubator 170 L, IR Sensor, CO ₂ & O ₂ Control, ULPA, Moist Heat Decon, Flat Door, 115 VAC, 50/60 Hz
CCL-240T-9-FD	2170127	CelCulture® Incubator 240 L, IR Sensor, CO ₂ & O ₂ Control, ULPA, Moist Heat Decon, Flat Door, 115 VAC, 50/60 Hz
CCL-170T-8-UV-FD	2170246	CelCulture® Incubator 170L, IR Sensor, CO ₂ & O ₂ Control, ULPA, UV Lamp, Moist Heat Decon, Flat Door, 230 VAC, 50/60 Hz
CCL-240T-8-UV-FD	2170248	Celculture® Incubator 240L, IR sensor, CO ₂ & O ₂ control, ULPA, UV Lamp, Moist Heat Decon, Flat Door, 230 VAC, 50/60 Hz

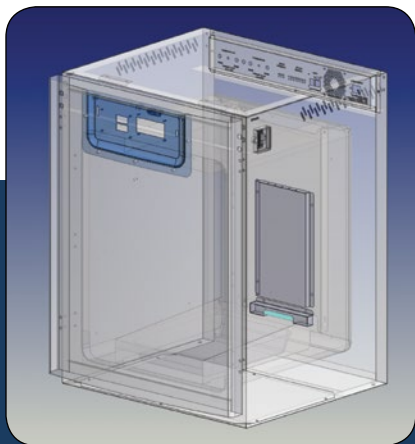

CelCulture® CO₂ Incubator with UV Lamp*

INTRODUCTION

Ozone-free UV lamp decontaminates the water in the humidity pan and the circulating air that flows across the water surface. The UV lamp is isolated from the inner chamber by the plenum cover, ensuring the safety of cell cultures from the UV decontamination.

WITH STAINLESS STEEL CHAMBER

MODELS	ITEM CODE	DESCRIPTION
CCL-170B-8-UV	2170031	CelCulture® Incubator 170 L, IR Sensor, CO ₂ Control, 90°C Moist Heat Decon, 220 - 240 VAC, 50/60 Hz
CCL-170B-9-UV	2170121	CelCulture® Incubator 170 L, IR Sensor, CO ₂ Control, 90°C Moist Heat Decon, 110 - 130 VAC, 50/60 Hz
CCL-170T-8-UV	2170043	CelCulture® Incubator 170 L, IR Sensor, CO ₂ , O ₂ Control, 90°C Moist Heat Decon, 220 - 240 VAC, 50/60 Hz
CCL-170T-9-UV	2170044	CelCulture® Incubator 170 L, IR Sensor, CO ₂ , O ₂ Control, 90°C Moist Heat Decon, 110 - 130 VAC, 50/60 Hz
CCL-240B-8-UV	2170094	CelCulture® Incubator 240 L, IR Sensor, CO ₂ Control, 90°C Moist Heat Decon, 220 - 240 VAC, 50/60 Hz
CCL-240B-9-UV	2170096	CelCulture® Incubator 240 L, IR Sensor, CO ₂ Control, 90°C Moist Heat Decon, 110 - 130 VAC, 50/60 Hz
CCL-240T-8-UV	2170097	CelCulture® Incubator 240 L, IR Sensor, CO ₂ , O ₂ Control, 90°C Moist Heat Decon, 220 - 240 VAC, 50/60 Hz
CCL-240T-9-UV	2170098	CelCulture® Incubator 240 L, IR Sensor, CO ₂ , O ₂ Control, 90°C Moist Heat Decon, 110 - 130 VAC, 50/60 Hz

WITH COPPER CHAMBER

MODELS	ITEM CODE	DESCRIPTION
CCL-170B-8-Cu-UV	2170099	CelCulture® Incubator 170 L, IR Sensor, CO ₂ Control, 90°C Moist Heat Decon, 220 - 240 VAC, 50/60 Hz
CCL-170B-9-Cu-UV	2170285	CelCulture® Incubator 170 L, IR Sensor, CO ₂ Control, 90°C Moist Heat Decon, 110 - 130 VAC, 50/60 Hz
CCL-240B-8-Cu-UV	2170154	CelCulture® Incubator 240 L, IR Sensor, CO ₂ Control, 90°C Moist Heat Decon, 220 - 240 VAC, 50/60 Hz
CCL-240B-9-Cu-UV	2170286	CelCulture® Incubator 240 L, IR Sensor, CO ₂ Control, 90°C Moist Heat Decon, 110 - 130 VAC, 50/60 Hz
CCL-170T-8-Cu-UV	2170131	CelCulture® Incubator 170 L, IR Sensor, CO ₂ , O ₂ Control, 90°C Moist Heat Decon, 220 - 240 VAC, 50/60 Hz
CCL-170T-9-Cu-UV	2170287	CelCulture® Incubator 170 L, IR Sensor, CO ₂ , O ₂ Control, 90°C Moist Heat Decon, 110 - 130 VAC, 50/60 Hz
CCL-240T-8-Cu-UV	2170155	CelCulture® Incubator 240 L, IR Sensor, CO ₂ , O ₂ Control, 90°C Moist Heat Decon, 220 - 240 VAC, 50/60 Hz
CCL-240T-9-Cu-UV	2170288	CelCulture® Incubator 240 L, IR Sensor, CO ₂ , O ₂ Control, 90°C Moist Heat Decon, 110 - 130 VAC, 50/60 Hz

WITH PELTIER COOLING MODE

MODELS	ITEM CODE	DESCRIPTION
CCL-170B-8-P-UV	2170204	CelCulture® Incubator 170 L, IR Sensor, CO ₂ Control, 90°C Moist Heat Decon, 220 - 240 VAC, 50/60 Hz
CCL-170B-9-P-UV	2170205	CelCulture® Incubator 170 L, IR Sensor, CO ₂ Control, 90°C Moist Heat Decon, 110 - 130 VAC, 50/60 Hz
CCL-170T-8-P-UV	2170206	CelCulture® Incubator 170 L, IR Sensor, CO ₂ , O ₂ Control, 90°C Moist Heat Decon, 220 - 240 VAC, 50/60 Hz
CCL-170T-9-P-UV	2170207	CelCulture® Incubator 170 L, IR Sensor, CO ₂ , O ₂ Control, 90°C Moist Heat Decon, 110 - 130 VAC, 50/60 Hz
CCL-240B-7-P-UV	2170289	CelCulture® Incubator 240 L, IR Sensor, CO ₂ Control, 90°C Moist Heat Decon, 100 VAC, 50/60 Hz
CCL-240B-8-P-UV	2170208	CelCulture® Incubator 240 L, IR Sensor, CO ₂ Control, 90°C Moist Heat Decon, 220 - 240 VAC, 50/60 Hz
CCL-240B-9-P-UV	2170209	CelCulture® Incubator 240 L, IR Sensor, CO ₂ Control, 90°C Moist Heat Decon, 110 - 130 VAC, 50/60 Hz
CCL-240T-7-P-UV	2170262	CelCulture® Incubator 240 L, IR Sensor, CO ₂ , O ₂ Control, 90°C Moist Heat Decon, 100 VAC, 50/60 Hz
CCL-240T-8-P-UV	2170210	CelCulture® Incubator 240 L, IR Sensor, CO ₂ , O ₂ Control, 90°C Moist Heat Decon, 220 - 240 VAC, 50/60 Hz
CCL-240T-9-P-UV	2170211	CelCulture® Incubator 240 L, IR Sensor, CO ₂ , O ₂ Control, 90°C Moist Heat Decon, 110 - 130 VAC, 50/60 Hz

*Not for sale in North America, Europe, Korea, Japan, Australia and New Zealand



CelCulture®
CO₂ Incubator with Copper Interior Chamber

Pure solid copper interior offers additional protection for your precious samples.

MAXIMUM CONTAMINATION CONTROL

Copper has been known for millennia to have antimicrobial properties. Copper can inhibit the growth of common culture microbial contaminants such as:

- *Escherichia coli*
- *Staphylococcus aureus*
- viruses

Other contamination control methods include:

- ✓ ULPA filter with 99.999% efficiency*
- ✓ 90°C Moist Heat Decontamination Cycle (HPA-Validated)
- ✓ 0.2 micron inlet filter for gas inputs
- ✓ ISOCIDE™ antimicrobial powder coating

**Not available in 50 L model*

IR SENSOR MODEL WITH 100% COPPER CHAMBER

MODELS	ITEM CODE	DESCRIPTION
CCL-050B-8-Cu	2170081	CelCulture® Incubator 50 L, IR Sensor, CO ₂ Control, Moist Heat Decon, 230 VAC, 50/60 Hz (Without Decon Pump)
CCL-170B-8-Cu	2170083	CelCulture® Incubator 170 L, IR Sensor, CO ₂ Control, ULPA, Moist Heat Decon, 230 VAC, 50/60 Hz
CCL-240B-8-Cu	2170085	CelCulture® Incubator 240 L, IR Sensor, CO ₂ Control, ULPA, Moist Heat Decon, 230 VAC, 50/60 Hz
CCL-050B-9-Cu	2170082	CelCulture® Incubator 50 L, IR Sensor, CO ₂ Control, Moist Heat Decon, 115 VAC, 50/60 Hz (Without Decon Pump)
CCL-170B-9-Cu	2170084	CelCulture® Incubator 170 L, IR Sensor, CO ₂ Control, ULPA, Moist Heat Decon, 115 VAC, 50/60 Hz
CCL-240B-9-Cu	2170086	CelCulture® Incubator 240 L, IR Sensor, CO ₂ Control, ULPA, Moist Heat Decon, 115 VAC, 50/60 Hz

SUPPRESSED O₂ MODEL WITH COPPER CHAMBER

MODELS	ITEM CODE	DESCRIPTION
CCL-050T-8-Cu	2170087	CelCulture® Incubator 50 L, IR Sensor, CO ₂ & O ₂ Control, Moist Heat Decon, 230 VAC, 50/60 Hz (Without Decon Pump)
CCL-170T-8-Cu	2170089	CelCulture® Incubator 170 L, IR Sensor, CO ₂ & O ₂ Control, ULPA, Moist Heat Decon, 230 VAC, 50/60 Hz
CCL-240T-8-Cu	2170111	CelCulture® Incubator 240 L, IR Sensor, CO ₂ & O ₂ Control, ULPA, Moist Heat Decon, 230 VAC, 50/60 Hz
CCL-050T-9-Cu	2170088	CelCulture® Incubator 50 L, IR Sensor, CO ₂ & O ₂ Control, Moist Heat Decon, 115 VAC, 50/60 Hz (Without Decon Pump)
CCL-170T-9-Cu	2170090	CelCulture® Incubator 170 L, IR Sensor, CO ₂ & O ₂ Control, ULPA, Moist Heat Decon, 115 VAC, 50/60 Hz
CCL-240T-9-Cu	2170092	CelCulture® Incubator 240 L, IR Sensor, CO ₂ & O ₂ Control, ULPA, Moist Heat Decon, 115 VAC, 50/60 Hz



CelCulture® CO₂ Incubator with Integrated Cooling System

INTRODUCTION

Esco CelCulture® CO₂ Incubator with Integrated Cooling System provides solution for highly specialized applications.

The integrated cooling system allows studies of samples that requires temperature at/or below ambient temperature.

KEY FEATURES

WIDER TEMPERATURE RANGE

Temperature range of 8°C below ambient to 60°C above ambient means wider range of applications.

HIGHLY EFFICIENT, ENVIRONMENT FRIENDLY PELTIER COOLING SYSTEM

This provides precise heating and cooling inside the chamber making sure that your samples are safe from temperature changes.

COMPLETE CONTAMINATION CONTROL METHODS

- 90 °C validated moist heat decontamination cycle
- ULPA filter
- ISOCIDE™ anti-microbial coating
- 0.2 micron inlet filter for gas inputs

IR SENSOR MODEL WITH INTEGRATED COOLING SYSTEM

MODELS	ITEM CODE	DESCRIPTION
CCL-170B-8-P	2170101	CelCulture® Incubator 170 L, IR Sensor, CO ₂ Control, Moist Heat Decon, Peltier System, 230 VAC, 50/60 Hz
CCL-170B-9-P	2170115	CelCulture® Incubator 170 L, IR Sensor, CO ₂ Control, Moist Heat Decon, Peltier System, 115 VAC, 50/60 Hz
CCL-240B-8-P	2170116	CelCulture® Incubator 240 L, IR Sensor, CO ₂ Control, Moist Heat Decon, Peltier System, 230 VAC, 50/60 Hz
CCL-240B-9-P	2170266	CelCulture® Incubator 240 L, IR Sensor, CO ₂ Control, Moist Heat Decon, Peltier System, 115 VAC, 50/60 Hz

SUPPRESSED O₂ MODEL WITH INTEGRATED COOLING SYSTEM

MODELS	ITEM CODE	DESCRIPTION
CCL-170T-8-P	2170112	CelCulture® Incubator 170 L, IR Sensor, CO ₂ & O ₂ Control, Moist Heat Decon, Peltier System, 230 VAC, 50/60 Hz
CCL-170T-9-P	2170153	CelCulture® Incubator 170 L, IR Sensor, CO ₂ & O ₂ Control, Moist Heat Decon, Peltier System, 115 VAC, 50/60 Hz
CCL-240T-8-P	2170267	CelCulture® Incubator 240 L, IR Sensor, CO ₂ & O ₂ Control, Moist Heat Decon, Peltier System, 230 VAC, 50/60 Hz
CCL-240T-9-P	2170268	CelCulture® Incubator 240 L, IR Sensor, CO ₂ & O ₂ Control, Moist Heat Decon, Peltier System, 115 VAC, 50/60 Hz



CelCulture® CO₂ Incubator with Stainless Steel Exterior Cabinet

- Corrosion-resistant Surface
- Meets Pharmaceutical and Clinical Laboratory Requirements

IR SENSOR MODEL WITH STAINLESS STEEL EXTERIOR CABINET

MODELS	ITEM CODE	DESCRIPTION
CCL-050B-8-SS	2170128	CelCulture® Incubator 50 L, IR Sensor, CO ₂ Control, Moist Heat Decon, SS Cabinet, 230 VAC, 50/60 Hz (Without Decon Pump)
CCL-170B-8-SS	2170065	CelCulture® Incubator 170 L, IR Sensor, CO ₂ Control, ULPA, Moist Heat Decon, SS Cabinet, 230 VAC, 50/60 Hz
CCL-240B-8-SS	2170137	CelCulture® Incubator 240 L, IR Sensor, CO ₂ Control, ULPA, Moist Heat Decon, SS Cabinet, 230 VAC, 50/60 Hz
CCL-050B-9-SS	2170176	CelCulture® Incubator 50 L, IR sensor, CO ₂ Control, Moist Heat Decon, SS Cabinet, 115 VAC, 50/60 Hz (Without Decon Pump)
CCL-170B-9-SS	2170177	CelCulture® Incubator 170 L, IR Sensor, CO ₂ Control, ULPA, Moist Heat Decon, SS Cabinet, 115 VAC, 50/60 Hz
CCL-240B-9-SS	2170140	CelCulture® Incubator 240 L, IR Sensor, CO ₂ Control, ULPA, Moist Heat Decon, SS Cabinet, 115 VAC, 50/60 Hz
CCL-170B-8-UV-SS	2170182	CelCulture® Incubator 170L, IR Sensor, CO ₂ Control, ULPA, UV Lamp, Moist Heat Decon, SS Cabinet, 230 VAC, 50/60 Hz
CCL-240B-8-UV-SS	2170183	CelCulture® Incubator 240L, IR Sensor, CO ₂ Control, ULPA, Moist Heat Decon, UV Lamp, SS Cabinet, 230 VAC, 50/60 Hz

SUPPRESSED O₂ MODEL WITH STAINLESS STEEL EXTERIOR CABINET

MODELS	ITEM CODE	DESCRIPTION
CCL-050T-8-SS	2170171	CelCulture® Incubator 50 L, IR Sensor, CO ₂ & O ₂ Control, Moist Heat Decon, SS Cabinet, 230 VAC, 50/60 Hz (Without Decon Pump)
CCL-170T-8-SS	2170129	CelCulture® Incubator 170 L IR Sensor, CO ₂ & O ₂ Control, ULPA, Moist Heat Decon, SS Cabinet, 230 VAC, 50/60 Hz
CCL-240T-8-SS	2170138	CelCulture® Incubator 240 L, IR Sensor, CO ₂ & O ₂ Control, ULPA, Moist Heat Decon, SS Cabinet, 230 VAC, 50/60 Hz
CCL-050T-9-SS	2170178	CelCulture® Incubator 50 L, IR Sensor, CO ₂ & O ₂ Control, Moist Heat Decon, SS Cabinet, 115 VAC, 50/60 Hz (Without Decon Pump)
CCL-170T-9-SS	2170179	CelCulture® Incubator 170 L, IR Sensor, CO ₂ & O ₂ Control, ULPA, Moist Heat Decon, SS Cabinet, 115 VAC, 50/60 Hz
CCL-240T-9-SS	2170141	CelCulture® Incubator 240 L, IR Sensor, CO ₂ & O ₂ Control, ULPA, Moist Heat Decon, SS Cabinet, 115 VAC, 50/60 Hz
CCL-170T-8-UV-SS	2180184	CelCulture® Incubator 170L, IR Sensor, CO ₂ & O ₂ Control, ULPA, UV Lamp, Moist Heat Decon, SS Cabinet, 230 VAC, 50/60 Hz
CCL-240T-8-UV-SS	2180185	CelCulture® Incubator 240L, IR Sensor, CO ₂ & O ₂ Control, ULPA, UV Lamp, Moist Heat Decon, SS Cabinet, 230 VAC, 50/60 Hz



CelCulture® CO₂ Incubator for *In Vitro* Fertilization

The CO₂ Incubator has a vital role in providing an optimal environment in embryo development during IVF and other ART procedures.

Sleek, reliable and intuitive, Esco CelCulture® CO₂ incubators for IVF are packed with outstanding features such as rapid parameter recovery, ISO Class 5 Cleanliness, ISOCIDE™ antimicrobial coating, standard Inner Door Kit feature that reduces contamination risk, and other accessories for specialized applications.



CCL-050_--IVF

KEY FEATURES

- Wider temperature range, from ambient +3°C temperature to 60°C.
- Complete contamination control methods to protect your precious samples.
- All gas inputs are filtered via 0.2 micron inlet filter and has ULPA filtration system.
- 90°C moist heat decontamination cycle, validated by HPA-UK.

IR SENSOR MODEL WITH STAINLESS STEEL CHAMBER

MODEL	ITEM CODE	DESCRIPTION
CCL-050B-8-IVF	2170257	Celculture® Incubator, 50L, IR sensor, CO ₂ control, Moist Heat Decon, with Sealed Inner Door Kit for 50L (2 Glass Doors with Latches), Factory Installed, 230VAC, 50/60 Hz
CCL-170B-8-IVF	2170272	CelCulture® Incubator 170L IR Sensor, CO ₂ Control ULPA, Moist Heat Decon, with Sealed Inner Door Kit for 170L (4 Glass Doors with Latches), Factory Installed, 230VAC 50/60Hz
CCL-240B-8-IVF	2170278	CelCulture® Incubator 240L IR Sensor CO ₂ Control, ULPA, Moist Heat Decon, with Sealed Inner Door Kit for 240L (4/6 Glass Doors with Latches), Factory Installed, 230VAC 50/60Hz
CCL-050B-9-IVF	2170258	Celculture® Incubator, 50L, IR sensor, CO ₂ control, Moist Heat Decon, with Sealed Inner Door Kit for 50L (2 Glass Doors with Latches), Factory Installed, 115VAC, 50/60 Hz
CCL-170B-9-IVF	2170273	CelCulture® Incubator 170L IR Sensor, CO ₂ Control ULPA, Moist Heat Decon, with Sealed Inner Door Kit for 170L (4 Glass Doors with Latches), Factory Installed, 115VAC 50/60Hz
CCL-240B-9-IVF	2170279	CelCulture® Incubator 240 L, IR Sensor, CO ₂ Control, ULPA, Moist Heat Decon with Sealed Inner Door Kit for 240L (4/6 Glass Doors with Latches), Factory Installed, 115VAC 50/60Hz

SUPPRESSED O₂ MODEL WITH STAINLESS STEEL CHAMBER

MODEL	ITEM CODE	DESCRIPTION
CCL-050T-8-IVF	2170260	Celculture® Incubator, 50L, IR sensor, CO ₂ & O ₂ control, Moist Heat Decon, with Sealed Inner Door Kit for 50L (2 Glass Doors with Latches), Factory Installed, 230VAC, 50/60 Hz
CCL-170T-8-IVF	2170275	CelCulture® Incubator 170L IR Sensor, CO ₂ & O ₂ Control ULPA, Moist Heat Decon, with Sealed Inner Door Kit for 170L (4 Glass Doors with Latches), Factory Installed, 230VAC 50/60Hz
CCL-240T-8-IVF	2170281	Celculture® Incubator, 240L, IR sensor, CO ₂ & O ₂ control, Moist Heat Decon, with Sealed Inner Door Kit for 240L (4/6 Glass Doors with Latches), Factory Installed, 230VAC 50/60Hz
CCL-050T-9-IVF	2170261	Celculture® Incubator, 50L, IR sensor, CO ₂ & O ₂ control, Moist Heat Decon, with Sealed Inner Door Kit for 50L (2 Glass Doors with Latches), Factory Installed, 115VAC, 50/60 Hz
CCL-170T-9-IVF	2170276	CelCulture® Incubator 170L IR Sensor, CO ₂ & O ₂ Control ULPA, Moist Heat Decon, with Sealed Inner Door Kit for 170L (4 Glass Doors with Latches), Factory Installed, 115VAC 50/60Hz
CCL-240T-9-IVF	2170282	Celculture® Incubator, 240L, IR sensor, CO ₂ & O ₂ control, Moist Heat Decon, with Sealed Inner Door Kit for 240L (4/6 Glass Doors with Latches), Factory Installed, 115VAC 50/60Hz

TECHNICAL SPECIFICATIONS

Front view

Side view

Rear view

MODEL 50 L

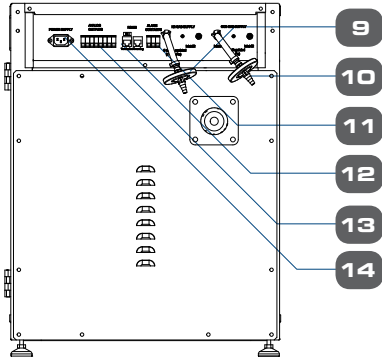
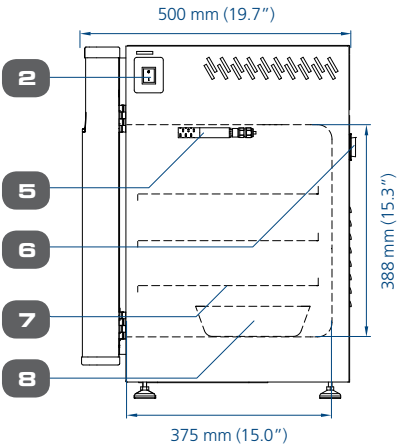
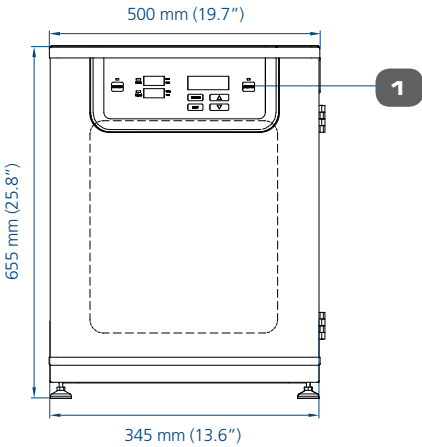

MODEL 170 L

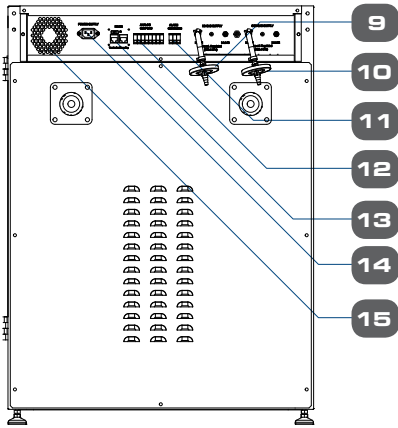
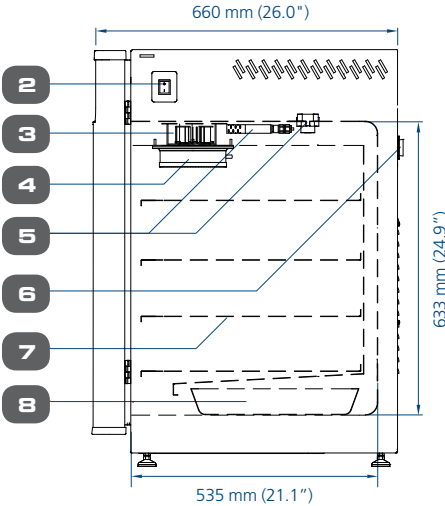
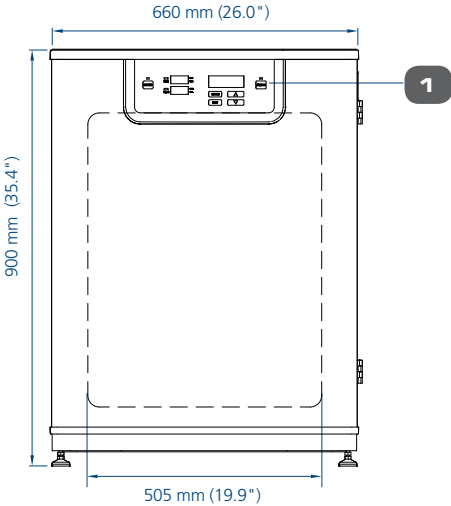

MODEL 240 L

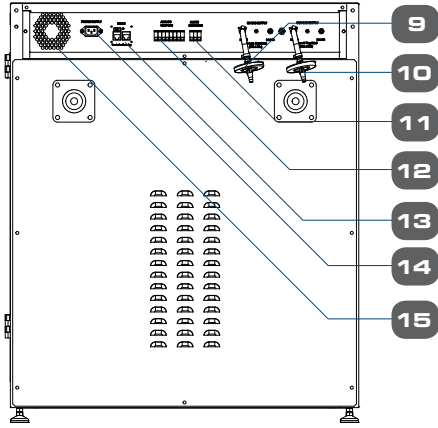
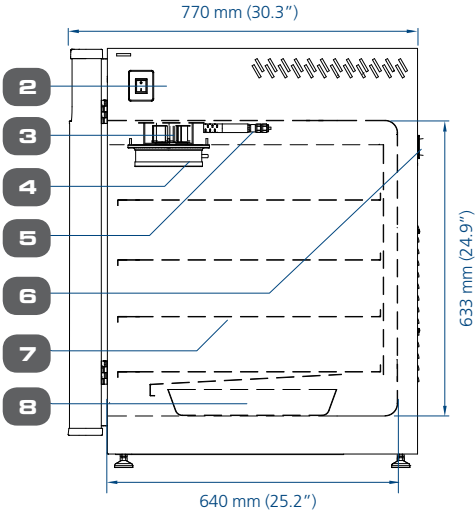
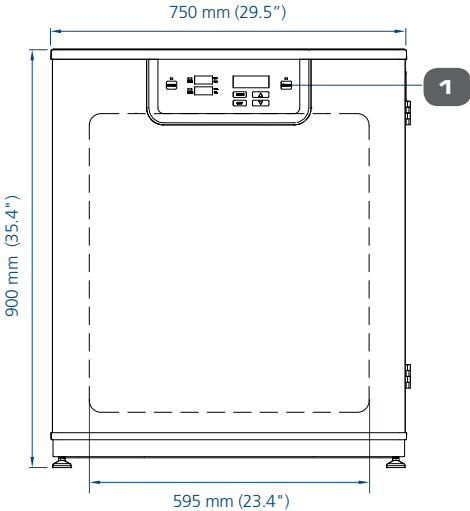

- 1. Control panel
- 2. On / off switch
- 3. Blower fan
- 4. ULPA filter
- 5. Sensors

- 6. Access port
- 7. Adjustable shelves
- 8. Humidity pan
- 9. N₂ gas supply
- 10. CO₂ gas supply

- 11. Alarm contact
- 12. Analog output
- 13. RS485
- 14. Power supply inlet
- 15. Cooling fan

GENERAL SPECIFICATIONS

CEL CULTURE® CO₂ INCUBATORS

	CCL-050_ -	CCL-170_ -	CCL-240_ -	
TEMPERATURE				
Temperature Control Method	Direct heat & Air Jacket using Microcontroller PI			
Ambient Temperature Range	18 to 34 °C (64 to 93 °F)			
Temperature Range, °C	Ambient +3 to 60			
Temperature Uniformity, °C	< ±0.5			
Temperature Accuracy, °C	< ±0.1			
Temperature Recovery Time* (after 30 seconds door opening, 97% from initial value)	≤4 minutes	≤5 minutes	≤6 minutes	
CO₂				
CO ₂ Control System	Microcontroller PI			
CO ₂ Range, % CO ₂	0-20			
CO ₂ Accuracy, % CO ₂	±0.1			
CO ₂ Sensor	Infrared (IR) Sensor			
CO ₂ Recovery Time** (after 30 seconds door opening)	Standard Unit: ≤6 minutes Suppressed O ₂ model: ≤8 minutes	Standard Unit: ≤5 minutes Suppressed O ₂ model: ≤6 minutes	Standard Unit: ≤6 minutes Suppressed O ₂ model: ≤8 minutes	
O₂ (FOR SUPPRESSED O₂ MODEL)				
O ₂ Control System	Microcontroller PI			
O ₂ Range, % O ₂	1-20.7			
O ₂ Accuracy, % O ₂	± 0.1			
O ₂ Sensor	Zirconia O ₂ sensor			
HUMIDITY				
Humidification Method	Humidity pan			
Humidity Range***, % RH	Standard Unit: Up to 95% Suppressed O ₂ model: Up to 91%			
PHYSICAL CONSTRUCTION				
Interior Volume	50 L (1.8 ft ³)	170 L (6 ft ³)	240 L (8.5 ft ³)	
External Dimensions (W x D x H)	500 x 500 x 655 mm (19.7" x 19.7" x 25.8")	660 x 660 x 900 mm (26.0" x 26.0" x 35.4")	750 x 770 x 900 mm (29.5" x 30.3" x 35.4")	
Internal Dimensions (W x D x H)	345 x 375 x 388 mm (13.6" x 14.8" x 15.3")	505 x 535 x 633 mm (19.9" x 21.1" x 24.9")	595 x 640 x 633 mm (23.4" x 25.2" x 24.9")	
Chamber Construction	Main Body	Electrogalvanized steel with ISOCIDE™ antimicrobial coating		
	Interior Material	Stainless steel, type 304		
	Number of Shelves	3	4	4
	Maximum Number of Shelves	4	7	7
	Shelves Area	300 x 335 mm (11.8" x 13.2")	465 x 470 mm (18.3" x 18.5")	550 x 560 mm (21.7" x 22.0")
	Maximum Load per Shelf	4 kg/shelf (8.8 lbs/shelf)	11 kg/shelf (24.3 lbs/shelf)	15 kg/shelf (33.1 lbs/shelf)
Electrical Configuration 110-130 VAC, 50/60 Hz	Nominal Power at 37°C	40.9 W	42.2 W	42.2 W
	Maximum Power Consumption	675.5 W	1184.3 W	1727.9 W
	Full Load Amps	5.3 A	9.2 A	13.4 A
Electrical Configuration 220-240 VAC, 50/60 Hz	Nominal Power at 37°C	40.9 W	42.2 W	42.2 W
	Maximum Power Consumption	598.8 W	1008.9 W	1270 W
	Full Load Amps	2.5 A	4.2 A	6.5 A
Net Weight	52 kg (114.6 lbs)	101 kg (222.7 lbs)	121 kg (266.8 lbs)	
Shipping Weight	70 kg (154.3 lbs)	120 kg (264.6 lbs)	155 kg (341.7 lbs)	
Shipping Dimensions (W x D x H)	660 x 650 x 900 mm (26.0" x 25.6" x 35.4")	850 x 720 x 1120 mm (33.5" x 28.3" x 44.1")	850 x 850 x 1120 mm (33.5" x 33.5" x 44.1")	
Shipping Volume	0.39 m ³ (13.7 ft ³)	0.70 m ³ (24.85 ft ³)	0.79 m ³ (28.03 ft ³)	
CONTAMINATION CONTROL				
Contamination Control Methods	1) Main body is electrogalvanized steel with ISOCIDE™ antimicrobial coating; 2) 90°C Moist Heat Decontamination Cycle (HPA Validated); 3) 0.2 micron inlet filter for gas inputs; 4) ULPA filter****			

All data recorded is specified for standard models with unloaded chambers and tested under optimum factory setting conditions of 23 °C and 60% ambient humidity.

*For temperature not exceeding 37 °C .

**For CO₂ level not exceeding 5.2%.

***Esco does not guarantee condensation-free chamber at humidity level higher than 90%.

****Not available for 50 L models.

OPTIONS AND ACCESSORIES



COA-1001 / COA-1001-F Humidity Display

This option allows the incubator to monitor the relative humidity inside the chamber. The probe for the sensor works in freezing conditions (-70°C) and also in temperatures up to 180°C. The sensor is easy to install and has excellent accuracy. The airflow in the chamber does not affect the measurement. The sensor is maintenance-free. It does not need to be removed during 90°C moist heat decontamination cycle.



COA-1002 / COA-1002-F CO₂ Backup

This option allows two tanks of CO₂ to be connected to the incubator. It will automatically switch from the primary tank to the secondary tank when low gas pressure is detected on the primary tank.

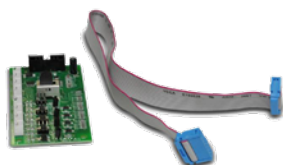

COA-1005 / COA-1005-F Analog Output

A set of relay contacts is provided at the rear of the incubator that allows the incubator to output analog signals representing the temperature, CO₂ / O₂ content and relative humidity, depending on the options available in your incubator. This allows the chamber to be connected to an in-house data acquisition or alarm system. This option can also be field-installed.

The analog signal outputs can be set to operate in either voltage DC (0-5 Vdc) or current (4-20 mA) mode. The factory default setting is voltage. Switch on the board to toggle between the modes.



COA-2030/ COA-2030-F Sealed Inner Door Kit with 2 glass doors (50L) COA-1006/ COA-1006-F Sealed Inner Door Kit with 4 glass doors (170L) COA-2029/ COA-2029-F Sealed Inner Door Kit with 4 glass doors (240L) COA-2040/ COA-2040-F Sealed Inner Door Kit with 6 glass doors (240L)

CelCulture® CO₂ incubators can be equipped with 2, 4 or 6 glass doors, that can be opened horizontally which allows access to defined sections of the incubator without affecting much the inner atmosphere of the chamber. This minimizes recovery time and contamination risks. The sealed-inner door is also reversible as same as the outer door which can be installed to be opened either from-right-to-left or from-left-to right. The sealed-inner door is available as a factory-installed option or field installed retrofit kit.



COA-1007 / COA-1007-F N₂ Back-up

This option allows two tanks of N₂ to be connected to the incubator. It will automatically switch from the primary tank to the secondary tank when low gas pressure is detected on the primary tank.



COA-2018-F (50L) / COA-2001-F (170 L) / COA-2019-F (240 L) Roller Base

Roller base is available with casters for mobility of your incubators and to provide protection against floor contamination.



COA-2020-F (50L) / COA-2002-F (170 L) / COA-2021-F (240 L) Floor Stand 200 mm (8.0") With Adjustable Feet

Floor stands are available with adjustable feet, with a nominal range of 180 mm to 250 mm (7.1" to 9.8") for comfortable access to the incubator and to avoid floor contamination.



COA-2022-F (50L) / COA-2003-F (170 L) / COA-2023-F (240 L) Floor Stand 700 mm (27.6") With Casters

This support stand raises the incubator to a height of 700 mm (27.6") above the floor for comfortable access. It comes with casters for mobility of your incubators.



COA-2005-F 2-Stage Gas Regulator for CO₂/N₂

CO₂ and N₂ gas input regulators reduce pressure from the tank to the incubator. It has dual pressure gauges, barbed line connection and shut-off valve. It prevents over-pressurization of the gas supply into the incubator which could cause the tubing to burst.

- CGA 320 connector (U.S. Standard)
- BP-BS341-#8-NT4 connector (British Standard)
- G5/8-RH connector (China Standard)

Note: Compatible with European DIN477, French NFE29-650 and Australia AS2473



COA-2024-F (50L) / COA-2007-F (170 L) / COA-2025-F (240 L) Extra Shelf (Stainless Steel) for Standard Stainless Steel Chamber

COA-2026-F (50L) / COA-2027-F (170 L) / COA-2028-F (240 L) Extra Shelf (Copper) for Standard Copper Chamber

Each CelCulture® CO₂ incubator comes standard with 3 shelves for 50 L / 4 shelves for 170 L & 240L and it can accommodate up to a maximum of 4 shelves for 50 L / 7 shelves for 170 L & 240 L.



COA-2008-F Stacking Kit

The stacking kit is a provision to stack one incubator on top of another incubator. Four stacking brackets are included as standard inside the Accessories Kit Box with each incubator.



COA-2010-F Electronic CO₂ Analyzer, For CO₂ / Temp Measurement

COA-2016-F Electronic CO₂ + O₂ Analyzer, For CO₂ / O₂ / Temp Measurement

COA-2017-F Electronic CO₂ + O₂ + RH Analyzer, For CO₂ / O₂ / RH / Temp Measurement

The electronic analyzer allows the measurement of CO₂ concentration, O₂ concentration, relative humidity and temperature (temperature probe already included).



COA-2012-F 6" Chart Recorder, Temp, 115/230 VAC, 50/60 Hz

The chart recorder provides an easy-to-read graph of data vs time. It is a reliable, accurate, and stable instrument for on-the-spot written documentation of incubator chamber temperature. This model offers 6" chart of temperature data.



COA-2013-F 8" Chart Recorder, Temp/Temp, 115/230 VAC, 50/60 Hz

The chart recorder provides an easy-to-read graph of data vs time. It is a reliable, accurate, and stable instrument for on-the-spot written documentation of incubator chamber temperature. This model offers 8" chart of temperature data and comes with 2 remote probes for dual temperature monitoring.

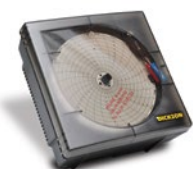

COA-2014-F 6" Chart Recorder, Temp/RH, 115/230VAC 50/60 Hz

The chart recorder provides an easy-to-read graph of data vs time. It is a reliable, accurate, and stable instrument for on-the-spot written documentation of incubator chamber temperature. This model offers 6" chart of temperature and humidity data.



COA-2015-F Inner Door Shelving Kit

(4 Sets With Total 12 Mini-Shelves For One Incubator) (170 L)

These mini-shelves are to be used with the Sealed Inner Door Kit installed. There are 4 sets with a total of 12 mini-shelves on each incubator.



5250001 Voyager® Software Kit

Esco Voyager® is a PC-based software package developed for the remote monitoring, datalogging and programming / device configuration of Esco controlled environment laboratory equipment. Compatible equipment includes laboratory ovens and incubators, low temperature incubators, CO₂ incubators, and ultra-low temperature freezers.

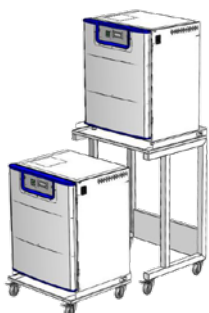

COA-2004 CCL-170 2-UNITS FLOOR STAND

This floor stand allows two units to be stacked without being physically in contact with each other. For the lower unit, it uses roller base for mobility and for easy pull out of the lower unit without the need to remove the upper unit in case of troubleshooting. Floor stand for upper unit also has casters for easy relocation.

FLOOR STAND TECHNICAL SPECIFICATIONS

Roller Base Model 170 L

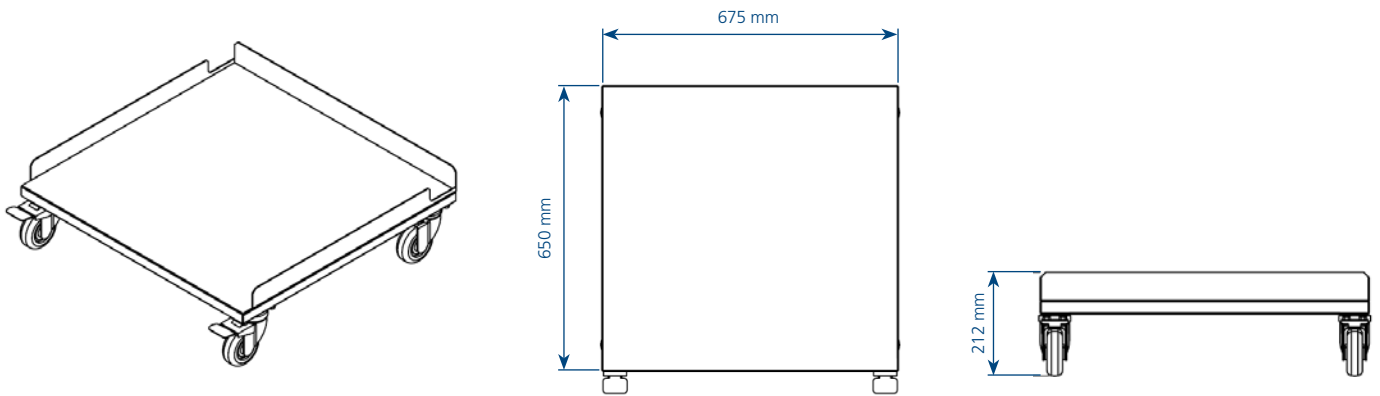

	COA-2018-F (50 L)	COA-2001-F (170 L)	COA-2019-F (240 L)
Dimensions (W x D x H)	510 x 500 x 212 mm	675 x 650 x 212 mm	765 x 740 x 212 mm

Floor Stand 200 mm (8.0") with Adjustable Feet, Model 170 L

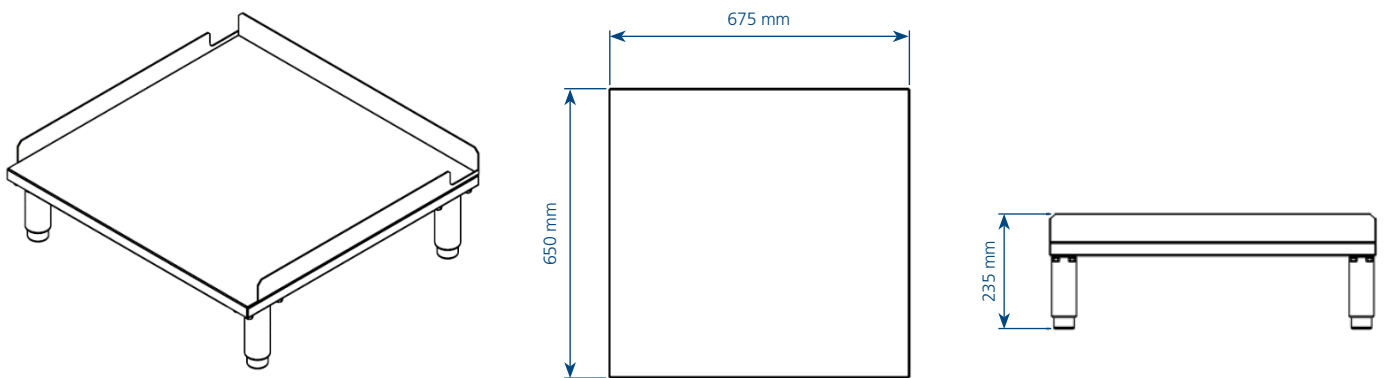

	COA-2020-F (50 L)	COA-2002-F (170 L)	COA-2021-F (240 L)
Dimensions (W x D x H)	510 x 500 x 235 mm	675 x 650 x 235 mm	765 x 740 x 235 mm

Floor Stand 700 mm (27.6") with Casters, Model 170 L

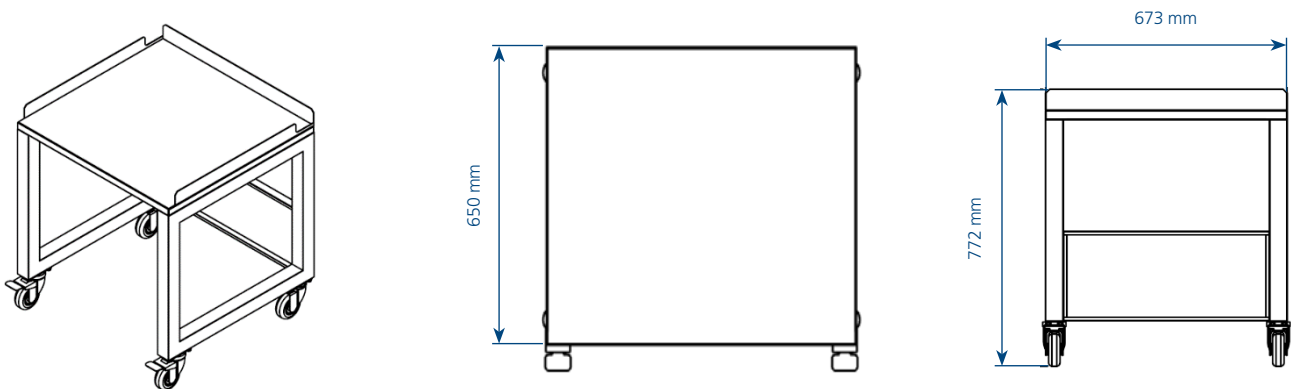

	COA-2022-F (50 L)	COA-2003-F (170 L)	COA-2023-F (240 L)
Dimensions (W x D x H)	510 x 500 x 772 mm	675 x 650 x 772 mm	765 x 740 x 737 mm

ORDERING INFORMATION

ACCESSORIES	ITEM CODE	DESCRIPTION
COA-1001	5170470	Humidity Display, Factory-installed
COA-1001-F	5170471	Humidity Display, Field-installed Kit
COA-1002	5170472	CO ₂ Backup (Tank Switcher), Factory-installed
COA-1002-F	5170473	CO ₂ Backup (Tank Switcher), Field-installed
COA-1004	5170474	Reversed Door Swing, Factory-installed
COA-1005	5170475	Analog Outputs, Factory-installed
COA-1005-F	5170476	Analog Outputs, Field-installed
COA-2030	5170672	Sealed Inner Door Kit for 50 L (2 Glass Doors with Latches), Factory-installed
COA-2030-F	5170673	Sealed Inner Door Kit for 50 L (2 Glass Doors with Latches), Field-installed
COA-1006	5170477	Sealed Inner Door Kit for 170 L (4 Glass Doors with Latches), Factory-installed
COA-1006-F	5170488	Sealed Inner Door Kit for 170 L (4 Glass Doors with Latches), Field-installed
COA-2029	5170654	Sealed Inner Door Kit for 240 L (4 Glass Doors with Latches), Factory-installed
COA-2029-F	5170655	Sealed Inner Door Kit for 240 L (4 Glass Doors with Latches), Field-installed
COA-2040	5170783	Sealed Inner Door Kit for 240 L (6 Glass Doors with Latches), Factory-installed
COA-2040-F	5170786	Sealed Inner Door Kit for 240 L (6 Glass Doors with Latches), Field-installed
COA-1007	5170490	N ₂ Back-up (Tank Switcher), Factory-installed
COA-1007-F	5170491	N ₂ Back-up (Tank Switcher), Field-installed
COA-2018-F	5170419	Roller Base (50 L)
COA-2001-F	5170478	Roller Base (170 L)
COA-2019-F	5170420	Roller Base (240 L)
COA-2020-F	5170421	Floor Stand 200 mm (8.0") with Adjustable Feet (50 L)
COA-2002-F	5170479	Floor Stand 200 mm (8.0") with Adjustable Feet (170 L)
COA-2021-F	5170422	Floor Stand 200 mm (8.0") with Adjustable Feet (240 L)
COA-2022-F	5170423	Floor Stand 700 mm (27.6") with Casters (50 L)
COA-2003-F	5170480	Floor Stand 700 mm (27.6") with Casters (170 L)
COA-2023-F	5170424	Floor Stand 700 mm (27.6") with Casters (240 L)
COA-2005-F	5170481	2-Stage Gas Regulator for CO ₂ / N ₂ Choose one of the connectors below: 1080588 - CGA 320 Connector (US standard) 1080589 - BP-B534-#8-NT4 Connector (British standard) 1080590 - G5/8-RH Connector (China standard)
COA-2024-F	5170425	Extra Shelf (50 L, Stainless Steel)
COA-2007-F	5170327	Extra Shelf (170 L, Stainless Steel)
COA-2025-F	5170426	Extra Shelf (240 L, Stainless Steel)
COA-2026-F	5170427	Extra Shelf (50 L, Copper)
COA-2027-F	5170428	Extra Shelf (170 L, Copper)
COA-2028-F	5170495	Extra Shelf (240 L, Copper)
COA-2008-F	5170483	Stacking Kit (one set included with every unit purchased)
COA-2010-F	5170329	Electronic CO ₂ Analyzer, For CO ₂ / Temp Measurement (with Temperature Probe)
COA-2016-F	5170397	Electronic CO ₂ + O ₂ Analyzer, For CO ₂ / O ₂ / Temperature Measurement (with Temperature Probe)
COA-2017-F	5170398	Electronic CO ₂ + O ₂ + RH Analyzer, For CO ₂ / O ₂ / RH / Temperature Measurement (with Temperature Probe)
COA-2011-F	2170020	IQ / OQ Documentation
COA-2012-F	2170021	6" Chart Recorder, Temp, 115/230 VAC, 50/60 Hz
COA-2013-F	2170022	8" Chart Recorder, Temp/Temp, 115/230 VAC, 50/60 Hz
COA-2014-F	2170023	6" Chart Recorder, Temp/RH, 115/230 VAC, 50/60 Hz
COA-2015-F	5170487	Inner Door Shelving Kit for 170 L (4 sets with total 12 mini-shelves for one incubator)
Voyager®	5250001	Voyager® Software Kit
COA-2004-F	5170489	2-units Floor Stand Stacking Kit (For 170L)

Advanced Cell Culture with Esco CO₂ Incubator and CelCradle™

CELCRADLE™ : CRADLE FOR HIGH DENSITY CELLS

CelCradle™ is a cost-effective, single-use benchtop bioreactor system capable of supporting high density culture of adherent cells. It is designed based on the concept of bellow-induced intermittent flow of media and air through porous matrices, where cells reside. This provides a low shear stress, high aeration, and foam-free culture environment.

During operation, the CelCradle™ bottle is partially filled with media and inoculated with cells. The media is raised and lowered alternately to submerge and expose the matrices, creating a dynamic interface between air and media on cell surface to maximize nutrient uptake and oxygen transfer.

CelCradle™ system is part of the tide motion bioreactor system, which features linear scalability up to 5,000 L packed bed volume!

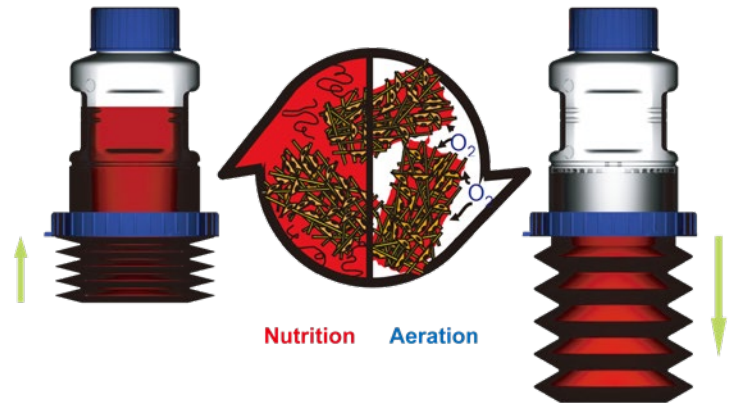

BioNOC™ II: Heart of the Tide Motion System

BioNOC™ II are macrocarriers that allow attachment of cells for adherent cell culture. Each CelCradle™ bottle consists of 5.5g of BioNOC™ II carriers, providing 15,000 cm² of surface area for attachment and growth of cells. Apart from its high surface area, BioNOC™ II carriers feature enhanced biocompatibility, long hydrophilicity, high porosity, low lint content, and excellent mechanical strength. The characteristics of BioNOC™ II, combined with the tide motion principle, allow the CelCradle™ system to support the high density culture of adherent cells.

Features:

- Stainless Steel 304 L BA CelCradle™ Stage capable of operating 4 CelCradle™ bottles simultaneously and compatible with a CO₂ incubator
- Pre-sterilized and ready-to-use disposable CelCradle™ bottles
- Provides a low shear stress and foam-free culture environment that has no O₂ limitation
- A single CelCradle™ bottle has the same productivity of up to 18-20 pieces of 850 cm² roller bottles
- Compact design allows the CelCradle™ to be placed inside a 6 ft³ CO₂ incubator
- Easy parameter optimization
- Capable of performing batch, fed-batch or perfusion culture mode
- Compatible with most media formulations including serum-free media
- Contains BioNOC™ II carriers with specially treated surface to allow growth of most anchorage-dependent cells. BioNOC™ II also allows easy harvest of whole cells, cell components or secreted proteins
- Easy-scale up by using additional bottles or by using TideCell® bioreactor system

Applications:

- Human and Animal Vaccines
- Autologous and Allogeneic Cell Therapy
- Culture of anchorage-dependent/ adherent cells
- Overcome limitations of stirred tank bioreactors using microcarriers
- Conversion from Roller Bottles to closed system, single-use cell culture
- Mammalian and insect cell research
- Monoclonal antibody production
- Protein production
- Vaccine production

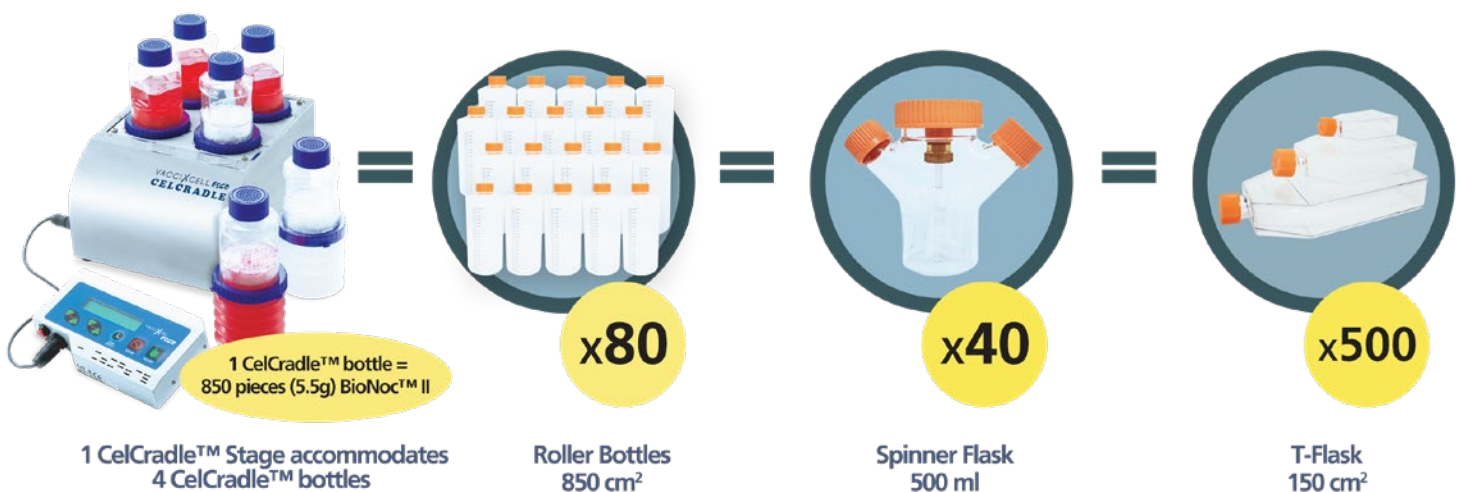

CELCRADLE™ BATCH SYSTEM

Useful for batch and semi-batch operation where process components are easily traceable.

Simple to operate - virtually no learning curve

Controller - adjusts nutrient and gas exchange of the bottle

Magnetized controller enables convenient positioning on the outside surface of the incubator



Bottle cap is integrated with 0.22µm ventilation filter

BioNOC™ II - acts as the packed bed where cells can adhere to, simplifying media replacement and product harvesting

Sampling Port - enables aseptic removal of BioNOC™ II macrocarriers for cell counting

Retaining Ring - locks bottle in place in the CelCradle™ Stage

Collapsible bellows

CELCRADLE™ CONTINUOUS SYSTEM

Extremely compact system fits in most standard CO₂ incubators.

Easy to read LED display

Up: 1.5 mm/s
T_H: 04 M 04 S



Useful for continuous operation where process components are easily traceable

Tubing set with peristaltic pump head enable recirculation and continuous feeding of nutrient

CelFeeder enables 4-pump operation with individual programming setting

Autoclavable pump head supports consistent, calibration-free feeding rate

DISPOSABLE CELCRADLE™ BOTTLES

A complete product line of CelCradle™ meets your specific needs. Different CelCradle™ bottles cover 90% of applications in cell culture.

- Batch, semi-batch or continuous culture
- BioNOC™ II carriers or preferred microcarriers
- Cell harvest with or without trypsin
- Disposable Bottle

Bottle	Item Code	Secreted Protein, viruses (adherent cells)	Cell Harvest (for non-secreted proteins, viruses or cells)	Carrier Harvest (for protein extraction or reuse of carriers)
CelCradle™ 500	1400001	Best Application	Applicable, but not optimal	Applicable, but not optimal
CelCradle™ 500A	1400003	Applicable, but not optimal	Best Application	Best Application
CelCradle™ 500P	1400002	Best Application	Applicable, but not optimal	Applicable, but not optimal
CelCradle™ 500AP	1400004	Applicable, but not optimal	Best Application	Best Application

OPTIONS AND ACCESSORIES

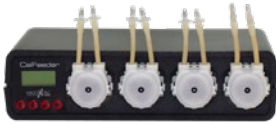

CelFeeder

The CelFeeder pump module is an auxiliary peristaltic pump used for the recirculation or perfusion processes for CelCradle™ 500 high density continuous cell culture system.



Tubing Complete Set

The Tubing Complete Set includes pre-assembled tubes, reusable pump head and head plate with a sampling port to support the continuous culture in CelCradle™-500P system.



Disposable Tubing Accessory

The Disposable Tubing Accessory provides simple options to replace the tubes in the Tubing Complete Set. This replacement avoid tubing deterioration during operation. It is recommended to replace the tubes after three (3) times of use.



GlucCell® Glucose Monitoring System

The GlucCell® enables simple and accurate glucose measurements using disposable test strips.



Crystal Violet Dye Nucleus Count Kit





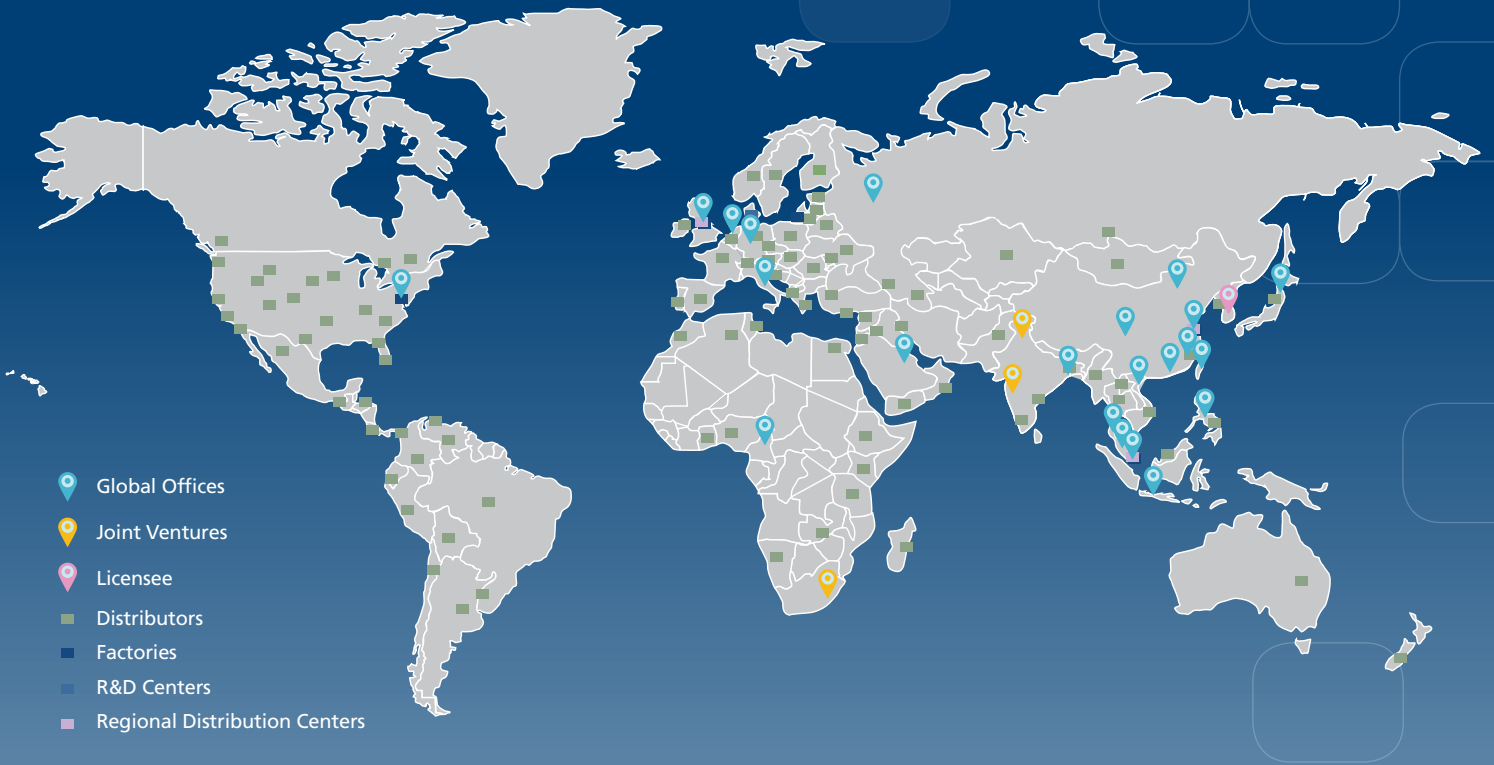

The Crystal Violet Dye Nucleus Count Kit contains crystal violet dye, citric acid and detergent used to disrupt the cells and release cell nuclei for cell count. The CVD kit is an efficient reagent for cell count in a porous matrix.

ORDERING INFORMATION

Product Name	Item Code	Package
CelCradle™ System Complete	2230006	1 x CelCradle™ Stage 1 x GlucCell® Glucose Monitoring System
CelCradle™ Continuous System Complete	2230007	1 x CelCradle™ Stage 1 x GlucCell® Glucose Monitoring System 1 x CelFeeder Pump 2 x Tubing Complete Set
CelCradle™ Stage	2230005	1 x Main Console 1 x Control Box 1 x 100-240 V power adapter 1 x Signal Cable 1 x Manual CD 2 x Forceps 1 x Crystal Violet Dye Nucleus Count Kit
CelFeeder Pump	1400067	1 x CelFeeder Pump
Tubing Complete Set	1400011	1 x Disposable Tubing Accessory 1 x Pump Head 1 x Head Plate
Disposable Tubing Accessory	1400013	5 x Disposable Tubing Accessory
Disposable Tubing Set & Pump Head	1400012	1 x Tubing Set 1 x Pump Head
GlucCell® Glucose Monitoring System	1400009	1 x GlucCell® Glucose meter 2 x Glucose Test Strip Bottles (2 x 25 pcs)
GlucCell® Glucose Test Strip	1400010	2 x Glucose Test Strip Bottles (2 x 25 pcs)
Crystal Violet Dye Nucleus Count Kit	1400014	1 x CVD Bottle (100ml/bt)
Filtered Cap	1400015	Cap for CelCradle™ Bottle (Pack of 6)
Non-Vented Cap	1400016	Cap for CelCradle™ AP/P Bottle (Pack of 8)
Forceps	1400017	Used for sampling of BioNOC™ II carriers

ESCO GLOBAL NETWORK



-  Global Offices
-  Joint Ventures
-  Licensee
-  Distributors
-  Factories
-  R&D Centers
-  Regional Distribution Centers

ESCO

WORLD CLASS. WORLDWIDE.

Esco Micro Pte. Ltd. • 21 Changi South Street 1 • Singapore 486 777
 Tel +65 6542 0833 • Fax +65 6542 6920 • mail@escoglobal.com
 www.escoglobal.com

Esco Technologies, Inc. • 903 Sheehy Drive, Suite F, Horsham, PA 19044, USA
 Tel: +1 215-441-9661 • Fax 484-698-7757
 eti.admin@escoglobal.com • www.escolifesciences.us

Esco Global Offices: Bangladesh | Cameroon | China | Denmark | Germany | Hong Kong | India | Indonesia | Italy | Japan | Lithuania | Malaysia | Philippines | Russia | Singapore | South Africa | South Korea | Taiwan | Thailand | UAE | UK | USA | Vietnam

9010057_CelCulture CO2 Incubator brochure_A4_VN_011119
 Esco can accept no responsibility for possible errors in catalogues, brochures and other printed materials.
 Esco reserves the right to alter its products and specifications without notice. All trademarks and logos
 in this material are the property of Esco and the respective companies.

